

# AC Laminated Solenoid (Model A142)

ML2951

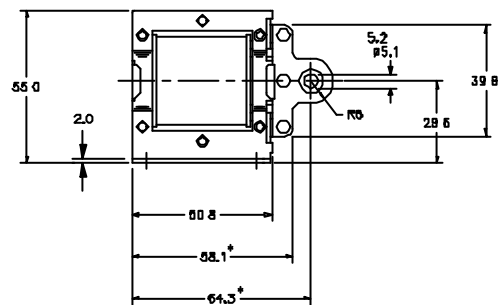

- Rugged Design for long Life
- Flying Leads or Tags
- Optional Voltage Ratings
- Copper Guides
- Copper Shading Rings
- Varnish Impregnated Coil
- Fast Response Time

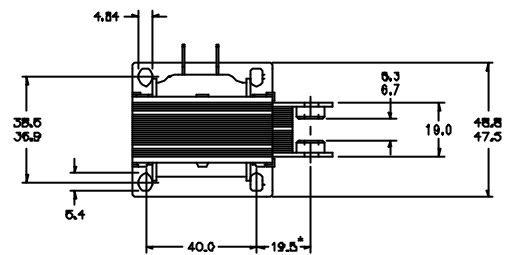
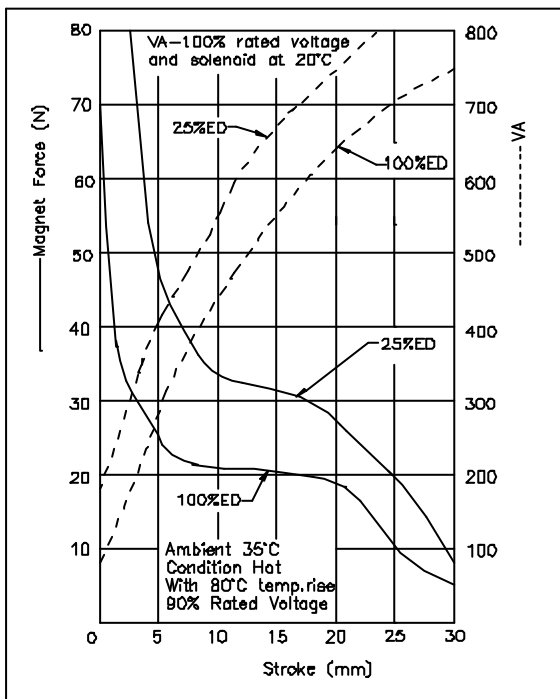

\* DIMENSIONS WITH SOLENOID ENERGISED  
TOLERANCES (UNLESS STATED) ±0.4mm