

- Ergonomic design with left- and right-hand options
- Front panel combinations including three rollers or up to eight switches
- Rear panel combinations of one roller or up to two switches
- Multi-color options for rollers and switches
- 16 logo options for switches
- Available pre-fitted to JC6000 or JC8000, or as a stand-alone grip
- Robust design for arduous applications
- Sealed to IP67
- EMC performance to 150V/m
- $MTTF_D > 900$ years



The HI Grip, which is available as a left- or right-hand option, offers a wide range of proportional, non-contacting roller and high-life, push-button switch combinations. Whereas most competitive products can support just three roller functions, the HI Grip can accommodate up to four.

A contoured front panel means the rollers are within an easy sweep of an operator's thumb, while the switch arrays are angled to allow for similarly convenient actuation.

The controls on the rear panel are situated to provide comfortable operation with a first finger. To further enhance operator comfort, both handed options are oriented to lean forward and inwards.

For maximum, application-specific flexibility, each roller and switch are offered in nine color options. Further customization is possible by a choice of 16 logos which can be printed in each of the switches.

In addition to being supplied fitted to a JC6000 or JC8000 joystick, the HI Grip can be supplied as a stand-alone product with an industry-standard, threaded mount and flying leads.

Careful material selection ensures maximum robustness to impact, liquids and dust, with the enclosure being sealed to IP67. An EMC performance level of 150V/m is provided, and the overall design achieves an $MTTF_D$ in excess of 900 years.



CONTENTS

Contents	2
Configuration & Options	3
Hand	4
Front Plate Layout	5
Front Plate Color.....	7
Front Function Cap Color and logo	8
Rear Plate Layout	11
Roller and Switch Layouts	11
Rear Plate Color	12
Rear Function Cap Color	12
Roller and Switch (Pushbutton) Layouts	13
Mechanical Interface Options	14
Electrical Interface Options.....	15
Gaiter Option	15
Installation	16
Mechanical - Right Hand	16
Mechanical - Left Hand.....	17
Electrical Connections	18
Specifications	19
Electrical - Rollers.....	19
Electrical - Switches.....	19
Mechanical - Grip.....	19
Mechanical - Roller	19
Mechanical - Switches	20
Materials	20
EMC and Magnetic field.....	20
Environmental and Legislative.....	20



CONFIGURATION & OPTIONS

HI-GEN-X-XX-X-N-XXXXXXXXXXXXXXXXXX-X-X-XXX-X-XX-X

Type	Hand	Front Plate Layout	Front Plate Color	Front Function Cap Color & Logo	Rear Plate Layout	Rear Plate Color	Rear Function Cap Color	Mechanical Interface	Electrical Interface	Gaiter
HI-GEN	X	XX	X	X...X	X	X	XXX	X	XX	X
	L	0A	B	B	N	B	B	A	5V	A
	R	0B	G	G	A	G	G	B		N
		0C		R	B		R	C		
		0D		E	C		E	D		
		0E		Y	D		Y	E		
		0F		L	E		L	F		
		0G		W	F		W	G		
		1A		O	G		O	H		
		1B		P	H		P	I		
		1C		/	I		/	J		
		1D		A-P	J					
		2A		/						
		2B								
		2C								
		2D								
		3A								
		3B								
		3C								
		3D								



HAND

HI-GEN-~~X~~-XX-X-N-XXXXXXXXXXXXXXXXXX-X-X-XXX-X-XX-X

Code	Description
L	Left-handed grip
R	Right-handed grip

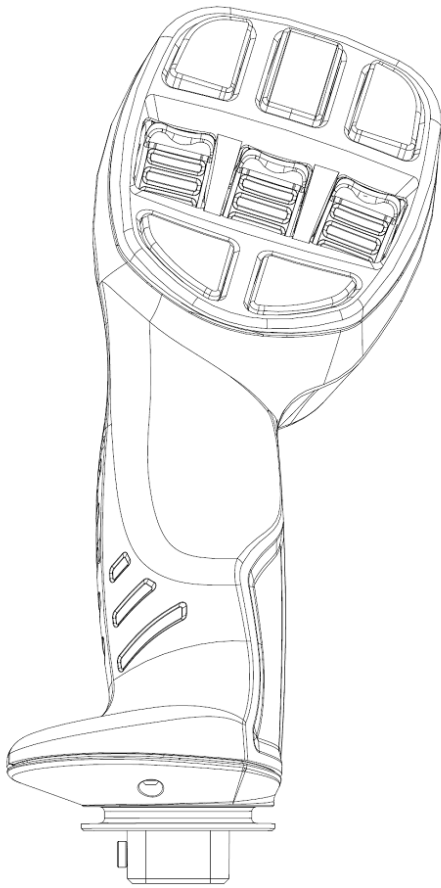

Left-handed Grip

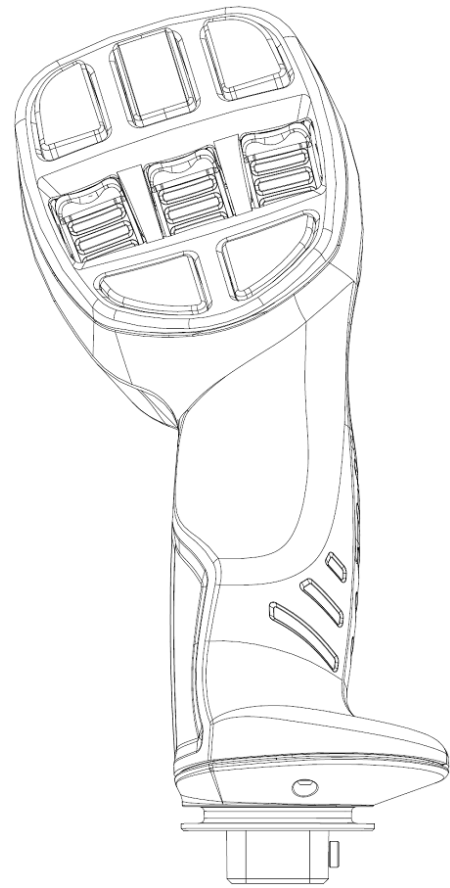

Right-handed Grip



FRONT PLATE LAYOUT

HI-GEN-X-XX-X-N-XXXXXXXXXXXXXXXXXX-X-X-XXX-X-XX-X

Code	Description
0A	2 Switches
0B	3 Switches
0C	4 Switches
0D	5 Switches
0E	6 Switches
0F	7 Switches
0G	8 Switches
1A	1 Roller and 2 Switches
1B	1 Roller and 3 Switches
1C	1 Roller and 4 Switches
1D	1 Roller and 5 Switches
2A	2 Rollers and 2 Switches
2B	2 Rollers and 3 Switches
2C	2 Rollers and 4 Switches
2D	2 Rollers and 5 Switches
3A	3 Rollers and 2 Switches
3B	3 Rollers and 3 Switches
3C	3 Rollers and 4 Switches
3D	3 Rollers and 5 Switches

See next page for diagrams of each front plate option.



Roller and Switch Layouts



0A



0B



0C



0D



0E



0F



0G



1A



1B



1C



1D



2A



2B



2C



2D



3A



3B



3C



3D



FRONT PLATE COLOR

HI-GEN-X-XX-X-N-XXXXXXXXXXXXXXXXXX-X-X-XXX-X-XX-X

Code	Description
B	Black (RAL 9005)
G	Grey (RAL 7042)

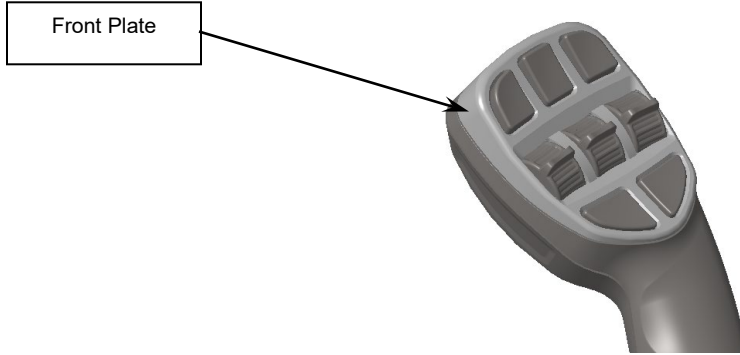



FRONT FUNCTION CAP COLOR AND LOGO

HI-GEN-X-XX-X-N-XXXXXXXXXXXXXXXXXX-X-X-XXX-X-XX-X

Each Roller/Switch detail is defined by a pair of characters – the first denoting color, the second a logo (Switches only). Each Roller/Switch position, 1-8, is defined per the diagram below.

Roller and Switch (Pushbutton) Identification

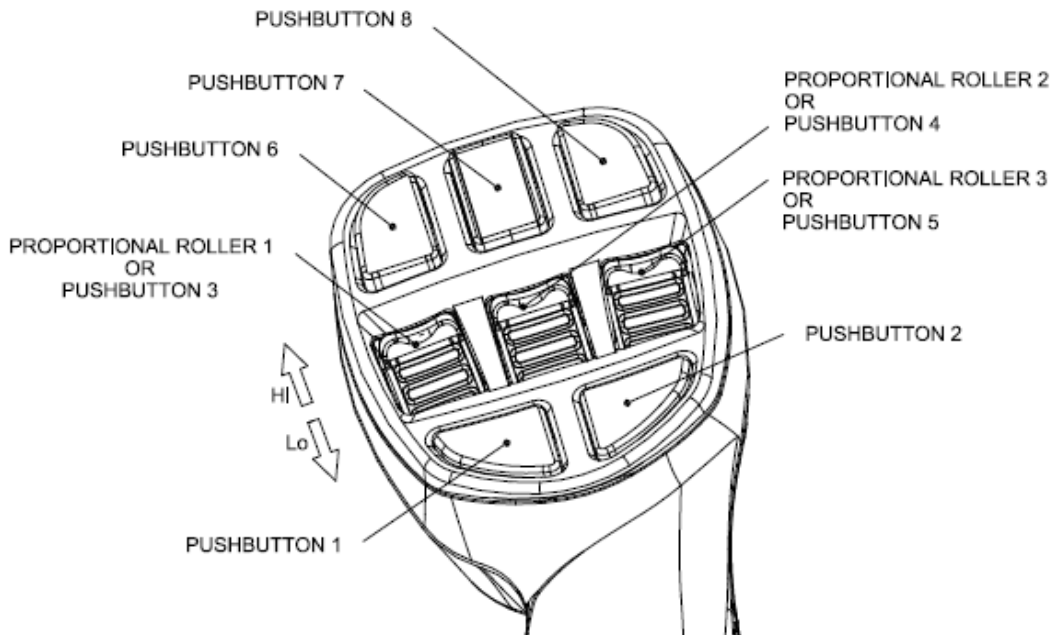



Roller and Switch (Pushbutton) Color Options

Code	Description
B	Black (RAL 9005)
G	Grey (RAL 7042)
R	Red (RAL 3028)
E	Green (RAL 6038)
Y	Yellow (RAL 1023)
L	Blue (RAL 5010)
W	White (RAL 9003)
O	Orange (RAL 2007)
P	Purple (RAL 4006)
/	Function not required

Note

Alternative colors can be supplied but may be subject to a minimum order quantity – please discuss with your Curtiss-Wright sales team.

Switch Logo Options

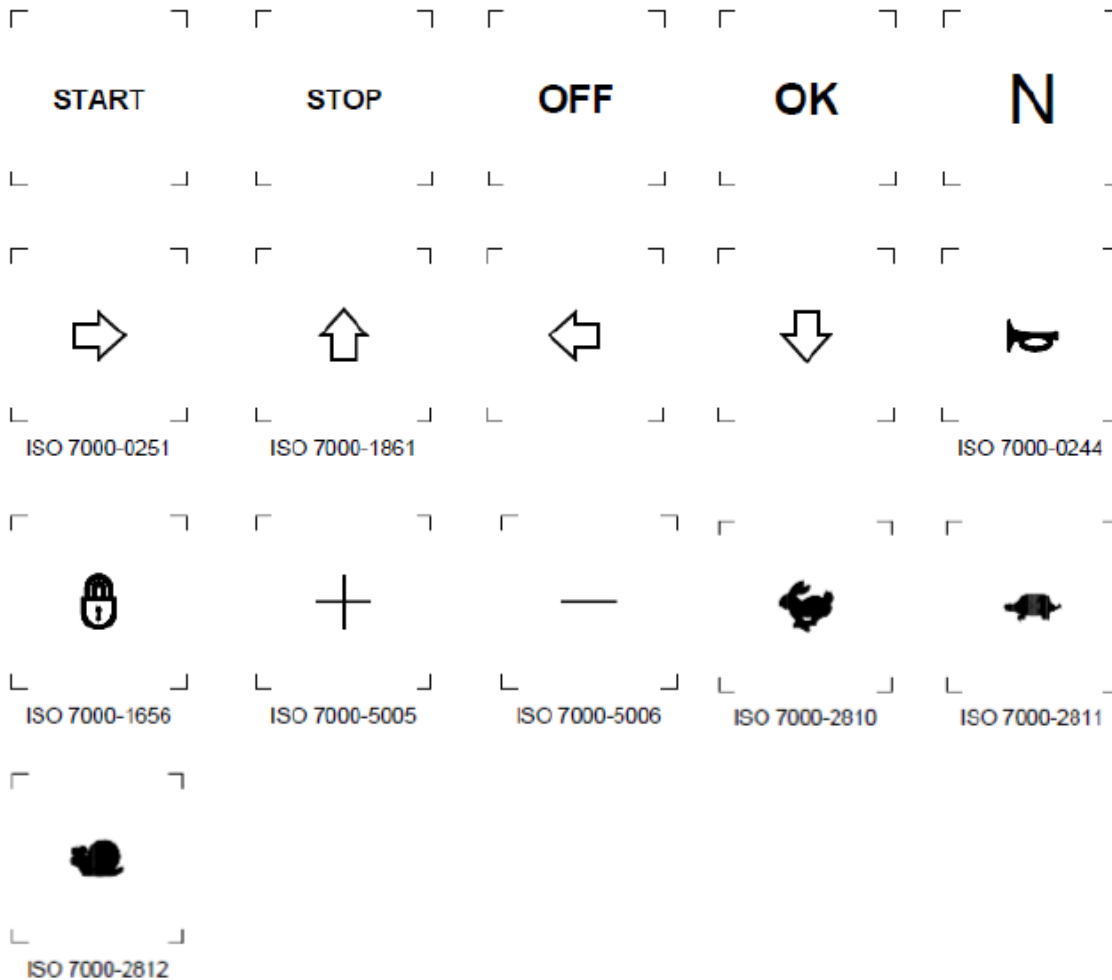



Code	Description
A	START
B	STOP
C	OFF
D	OK
E	N
F	Right arrow
G	Up arrow
H	Left arrow
I	Down arrow
J	Horn
K	Padlock
L	+
M	-
N	Hare
O	Tortoise
P	Snail
R	Default selection for a Roller
/	Logo not required

Example of Color and Logo Coding

A black Switch with a STOP logo = BB.

Logo Color

All logo will be in White except where the button is White, Grey or Yellow in which case the logo will be Black.

Rollers

Rollers are not available with a logo, so they are coded as the roller color followed by a default R so a Yellow roller = YR.



REAR PLATE LAYOUT

HI-GEN-X-XX-X-N-XXXXXXXXXXXXXXXXXX-X-X-XXX-X-XX-X

Code	Description
A (RIGHT HAND) OR B (LEFT HAND)	1 Switch
C (RIGHT HAND) OR D (LEFT HAND)	2 Switches
E (RIGHT HAND) OR F (LEFT HAND)	1 Horizontal Roller
G (RIGHT HAND) OR H (LEFT HAND)	1 Horizontal Roller and 1 Switch
I (RIGHT HAND) OR J (LEFT HAND)	No functions

Roller and Switch Layouts



A or B



C or D

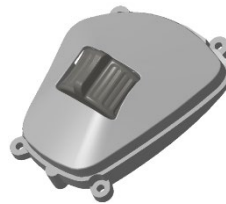

E or F

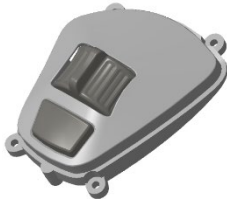

G or H

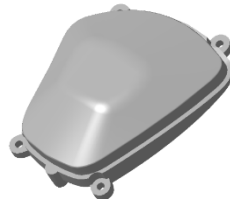

I or J



REAR PLATE COLOR

HI-GEN-X-XX-X-N-XXXXXXXXXXXXXXXXXX-X-X-XXX-X-XX-X

Code	Description
B	Black (RAL 9005)
G	Grey (RAL 7042)

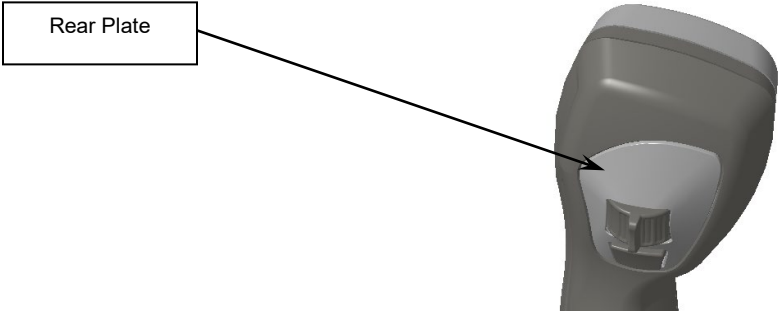

REAR FUNCTION CAP COLOR

HI-GEN-X-XX-X-N-XXXXXXXXXXXXXXXXXX-X-X-XXX-X-XX-X

Code	Description
B	Black (RAL 9005)
G	Grey (RAL 7042)
R	Red (RAL 3028)
E	Green (RAL 6038)
Y	Yellow (RAL 1023)
L	Blue (RAL 5010)
W	White (RAL 9003)
O	Orange (RAL 2007)
P	Purple (RAL 4006)
/	Function not required

See next page for identification of rollers and switches (buttons).

Note

Alternative colors can be supplied but may be subject to a minimum order quantity – please discuss with the Curtiss-Wright sales team.



Roller and Switch (Pushbutton) Layouts

Roller 4	Switch 9	Switch 10
X	X	X

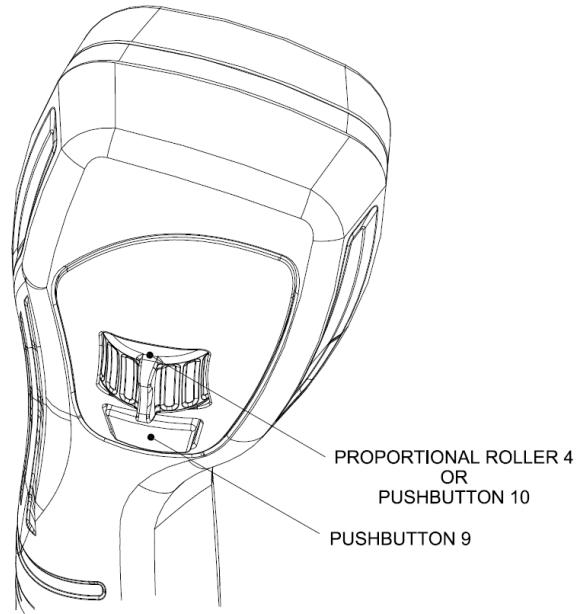



MECHANICAL INTERFACE OPTIONS

HI-GEN-X-XX-X-N-XXXXXXXXXXXXXXXXXX-X-X-XXX-~~X~~-XX-X

Code	Description
A (RIGHT HAND) OR B (LEFT HAND)	JC6000 Mounting – adapter fitted to suit mounting to the JC6000 joystick
C (RIGHT HAND) OR D (LEFT HAND)	JC8000 mounting – adapter fitted to suit mounting to the JC8000 joystick
E (RIGHT HAND) OR F (LEFT HAND)	M12 x 1.75mm (Internal)
G (RIGHT HAND) OR H (LEFT HAND)	M14 x 1.5mm (External)
I (RIGHT HAND) OR J (LEFT HAND)	M12 x 1.75mm (External)

Notes

If a grip is selected as part of a complete joystick assembly, the mechanical interface for that joystick will be the default. This section of the code will not appear in the complete Joystick/Grip code. Alternative adapters can be supplied but may be subject to a minimal order quantity – please discuss with your Curtiss-Wright sales team

Grip wires exit through the center of the “A” to “D” adapters and at the rear of the grip when the “E” to “J” adapters are fitted – see the “Installation” section for the details of the Code “E” to “J” cable exit point.

Details of the Required Machining of the Customer’s System Shaft/Operating rod

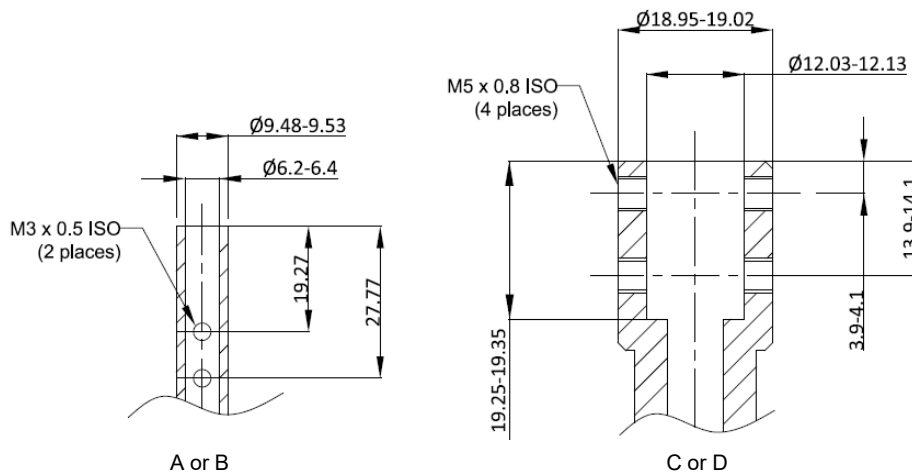

Details of the shaft exiting the HI grip

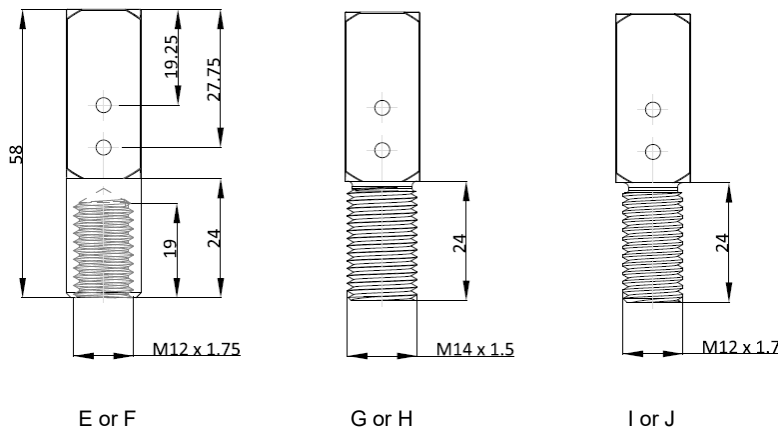



ELECTRICAL INTERFACE OPTIONS

HI-GEN-X-XX-X-N-XXXXXXXXXXXXXXXXXX-X-X-XXX-X-XX-X

Code	Description
5V	5V supply with analogue output through a flying lead

Notes

The maximum number of wires that can exit from a stand-alone grip is 16.

When the grip is mounted to a Curtiss-Wright joystick, the number of wires is limited by the size of the operating rod of that joystick. For a JC6000 joystick, this limit is 13 wires.

Refer to the “Electrical Connections” section of this document to determine the number of wires for any given configuration.

When the grip is selected as part of a complete joystick assembly the Electrical Interface Option will be the default of that joystick and will not appear in the complete Joystick/Grip code.

GAITER OPTION

HI-GEN-X-XX-X-N-XXXXXXXXXXXXXXXXXX-X-X-XXX-X-XX-X

Code	Description
A	JC6000 gaiter supplied fitted to grip
N	Gaiter not supplied

Notes

When a grip is selected as part of a complete joystick assembly, the gaiter fitted will be the default item for that joystick. This section of the code will not appear in the complete Joystick/Grip code.

The decision of the suitability of the gaiter for a particular application, when supplied with the stand-alone grip, is the responsibility of the customer.



INSTALLATION

MECHANICAL - RIGHT HAND

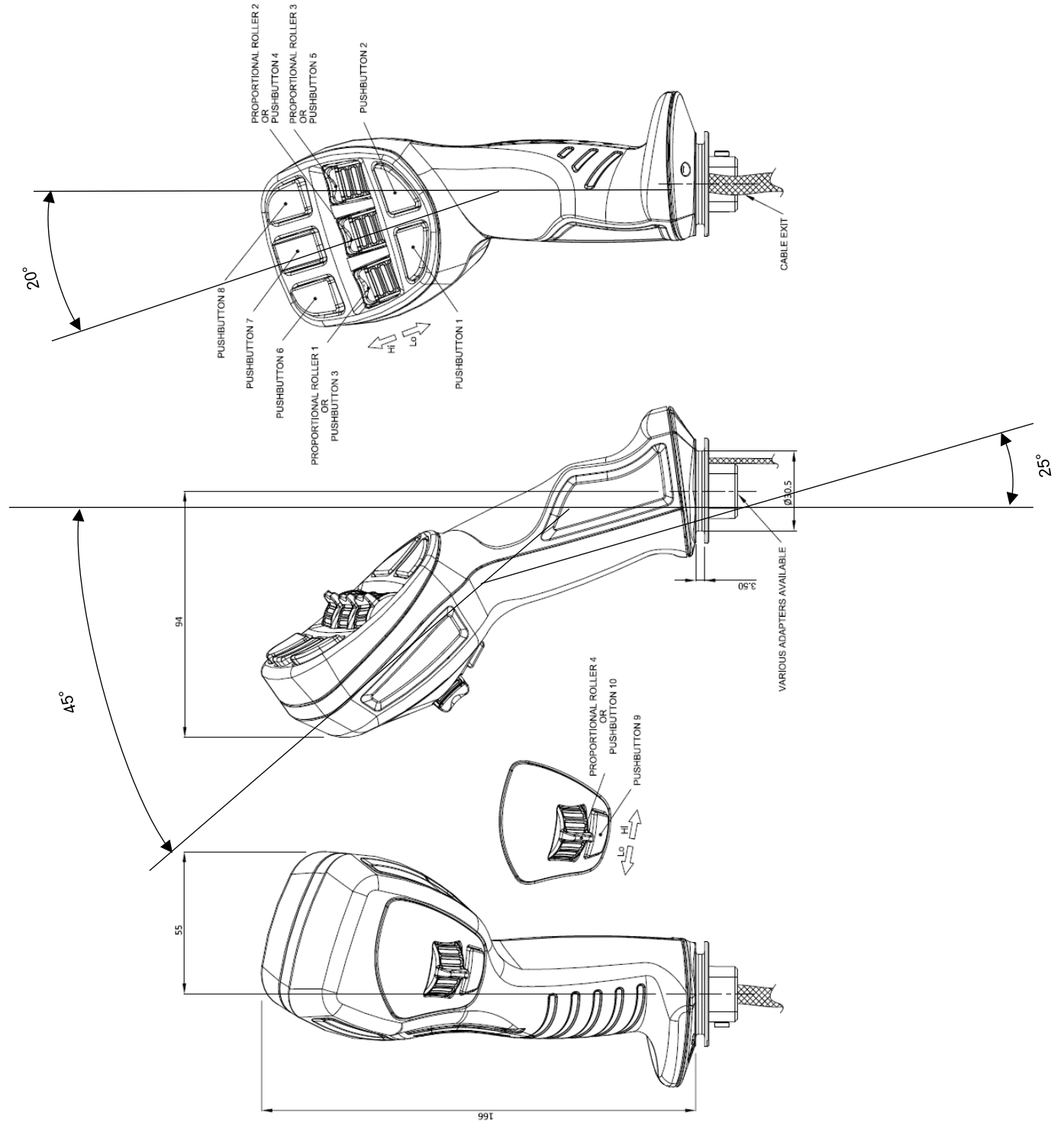



MECHANICAL - LEFT HAND

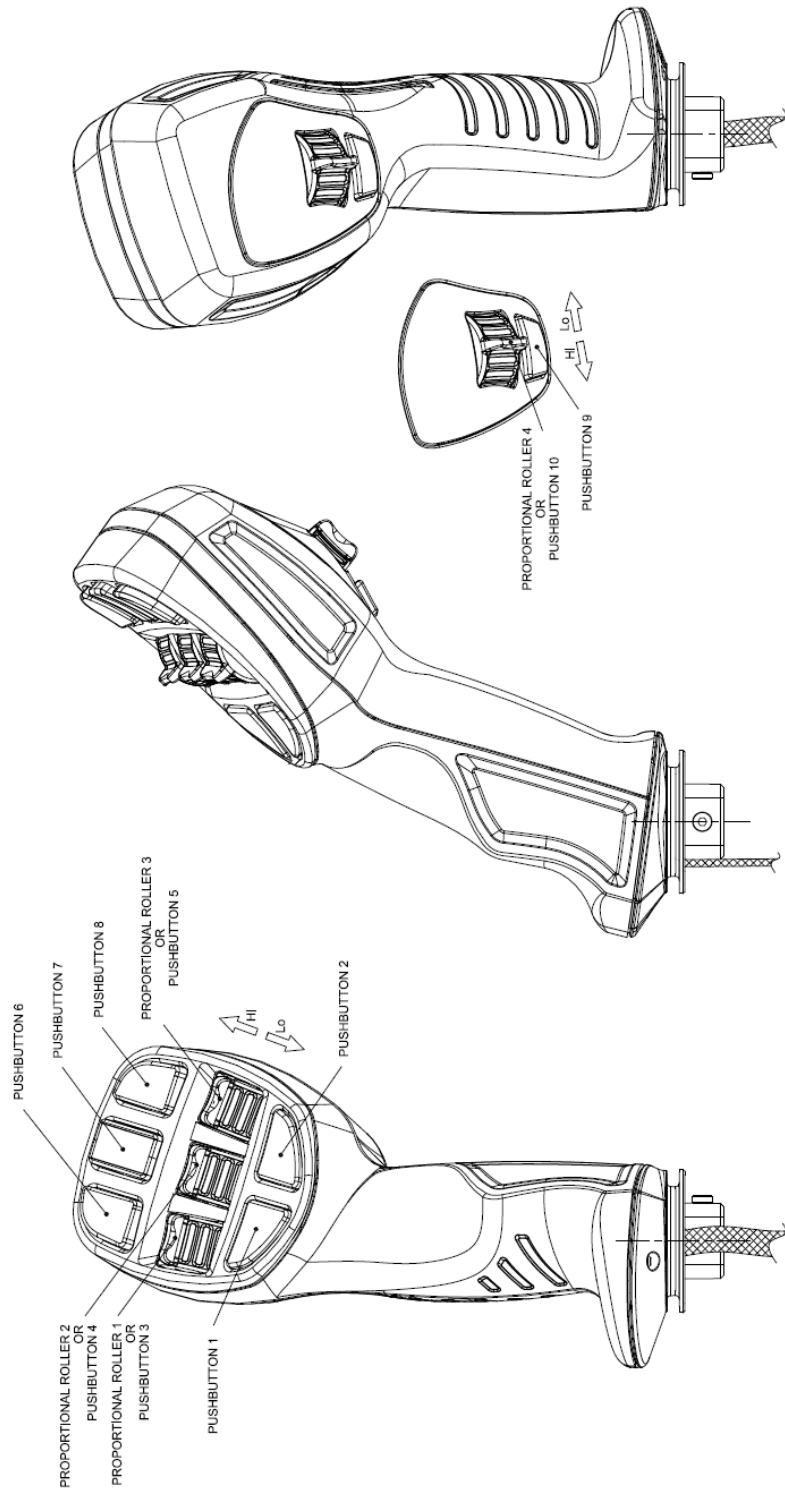

Panel cut-out for both left- and right-hand options is 70mm.



ELECTRICAL CONNECTIONS

FRONT SWITCHES

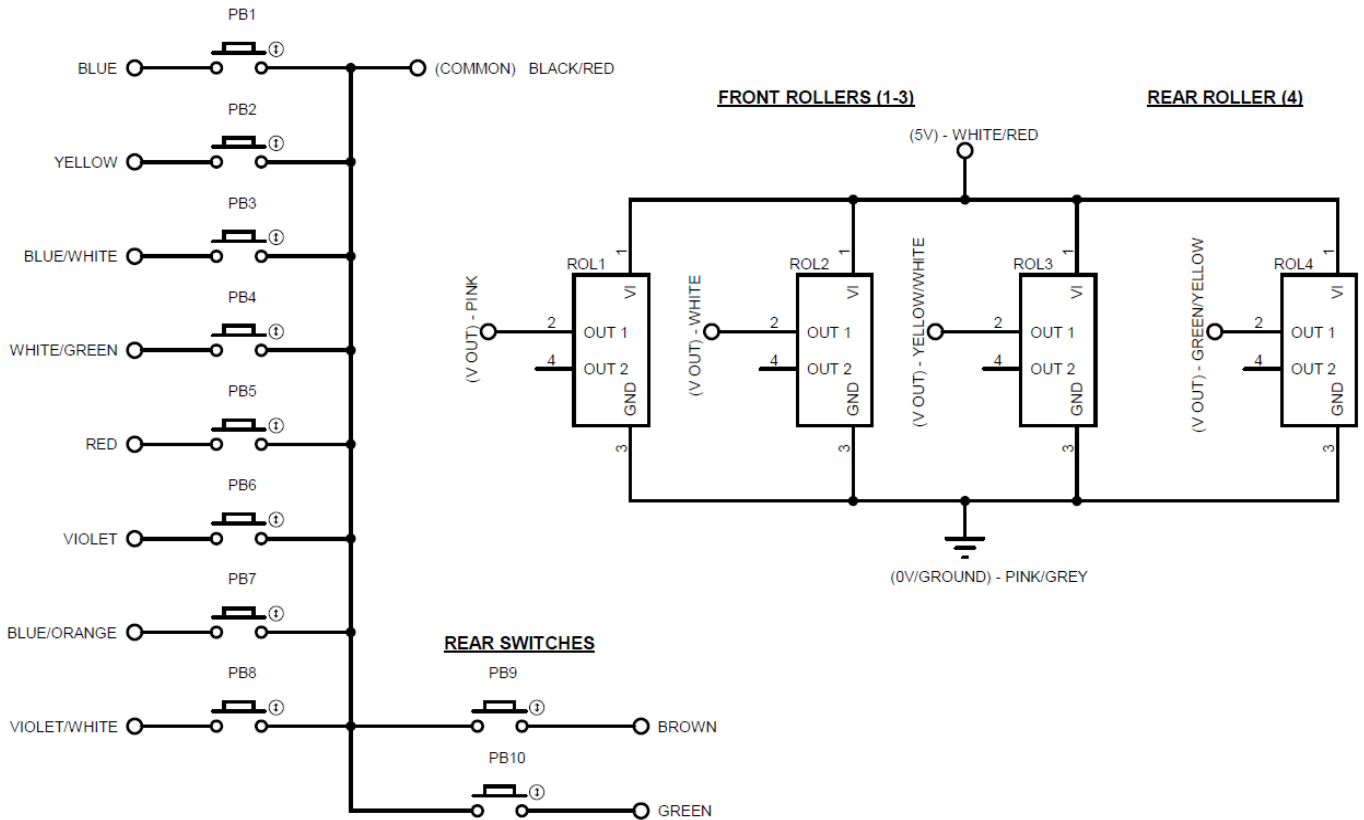

Note

If a grip is selected as part of a complete joystick assembly, the connection details will be defined in the generic joystick data sheet

CABLE TYPE

When the grip is supplied as a stand-alone assembly, it is fitted with PTFE insulated 22 AWG wires with a plastic protective braid and heat-shrink sleeving to secure the braid in position. The cable assembly is 300mm long from the grip exit to the end of the wires.

The cable will exit at the rear of the grip, and it is the responsibility of the customer to route the cable so as not to pinch or excessively bend in a dynamic application

When the grip supplied as part of a complete JC6000 or JC8100 joystick, it is fitted with PTFE insulated 26 AWG wires



SPECIFICATIONS

ELECTRICAL - ROLLERS

SUPPLY VOLTAGE	5Vdc \pm 0.5Vdc for the rollers
CURRENT CONSUMPTION	32mA max. per roller
ROLLER OUTPUT VOLTAGE (FACTORY SET)	10% to 90% of the Supply Voltage
CENTERING ACCURACY	50% \pm 5.5% of Supply Voltage
END ACCURACY	Low end: 10% +4.0/-2.0% of the Supply Voltage High end: 90% +2.0/-4.0% of the Supply Voltage
OUTPUT IMPEDANCE	100 Ω nominal
OUTPUT SENSE	The output will increase in the +ve direction – see the installation diagrams for details of the +ve direction
SUPPLY REVERSE POLARITY PROTECTION	-10Vdc continuous
INSULATION RESISTANCE @ 10VDC	>10M Ω

ELECTRICAL - SWITCHES

CONTACT RATING	24V, 50mA maximum per switch
CONTACT RESISTANCE	30 m Ω maximum
INSULATION RESISTANCE	>10 M Ω
ELECTRICAL LIFE	5-million cycles at maximum power
CONTACT BOUNCE	2ms maximum

MECHANICAL - GRIP

MAXIMUM OVERLOAD - STATIC	600N – applied at the center of the grip
MAXIMUM OVERLOAD - IMPACT	10J
MAXIMUM TORQUE	40Nm
WEIGHT	290g nominal

MECHANICAL - ROLLER

BREAKOUT FORCE	2N nominal	
MAXIMUM OVERLOAD AT END OF TRAVEL	50N – applied perpendicular to tab	
OPERATING ANGLE	\pm 35° for front roller(s) \pm 25° for rear roller	
MECHANICAL LIFE	5-million cycles	One cycle is defined as moving from center to the end of travel, returning past the center to the other end and back to center



MECHANICAL - SWITCHES

SWITCH TYPE	Momentary – normally-open
SWITCH TRAVEL	1mm
OPERATING FORCE	3.5N nominal
MAXIMUM OVERLOAD	115N
MECHANICAL LIFE	5-million operations

MATERIALS

GAITER	Silicone
GRIP MOLDINGS	Zytel 70G30L and 101L (glass-loaded Nylon 66)
BUTTON ACTUATOR	Lexan 123R (Polycarbonate)
ROLLER	Delrin 500 AL (Acetal)

EMC AND MAGNETIC FIELD

EMC IMMUNITY LEVEL	ISO 11452-2: 2004	80% AM peak modulation, 150V/m, 80MHz-3GHz
EMC EMISSIONS LEVEL	CISPR25	Frequency range: 30MHz-1GHz, vertical & horizontal 30-230MHz: 36dB (µV/m) 230MHz-1GHz: 43dB (µV/m)
ESD IMMUNITY LEVEL	ISO 10605: 2008	8kV contact (including wires); 15kV air discharge
CONDUCTED IMMUNITY	ISO 7637-2: 2004/2001	Pulses 1, 2a, 2b, 3a, 3b & 4 to 12V standard Pulse 5a: (unclamped) Pulse 5a: (clamped)
CONDUCTED DISTURBANCE IMMUNITY	ISO 11452-4: 2011	(BCI) 200mA 1-20MHz
POWER FIELD IMMUNITY	ISO 11452-8: 2007	100A/m 50-60Hz

ENVIRONMENTAL AND LEGISLATIVE

OPERATING TEMPERATURE (CYCLING)	BS EN 60068-2-14: 2000	-40°C to 85°C
STORAGE TEMPERATURE	Cold test to EN 60068-2-1: 1993 Dry heat to EN 60068-2-2: 1993	-40°C to 85°C
TEMPERATURE & HUMIDITY	BS EN 60068-2-38: 2009	Pt 2.1 Z/AD; 65°C for 10 cycles
WATER AND DUST INGRESS	BS EN 60529 IP66 and IP67	“Flow-in, flow-out” design. The internal components are sealed to meet IP67. Unless fitted to a Curtiss-Wright joystick, the cable exit point is open, and it is therefore the responsibility of the customer to ensure that the cable exit is adequately sealed for the application
SALT MIST	EN 60068-2-11: 1999	96 hours
VIBRATION (SINUSOIDAL)	EN 60068-2-6: 2008	3gn, 10-200Hz, 1h per axis
VIBRATION (RANDOM)	EN 60068-2-64: 2008	3.6gn, 10-200Hz, 2h per axis
SHOCK	EN 60068-2-27: 2008	50gn, ½ sine 6ms, 3 shocks in 6 directions
BUMP	EN 60068-2-27: 2008	25g, 10ms, 500 bumps in each of 6 directions
MTTFd	940 years	



IMPORTANT INFORMATION

Whilst Curtiss-Wright Industrial Group - Penny & Giles has designed this joystick to meet a range of applications it is the responsibility of the customer to ensure it meets their specific requirement.

Penny & Giles Controls Ltd makes no warranty or representation in respect of product fitness or suitability for any particular design application, environment, or otherwise, except as may subsequently be agreed in contract for the sale and purchase of products. Customers should therefore satisfy themselves of the actual performance requirements and subsequently the product's suitability for any particular design application and the environment in which the product is to be used.

Continual research and development may require change to products and specification without prior notification.

All trademarks acknowledged.